

MANIFOLD ASSEMBLY, AIR - 6 VALVE (AP11239) (WITH PRESSURE SWITCH)

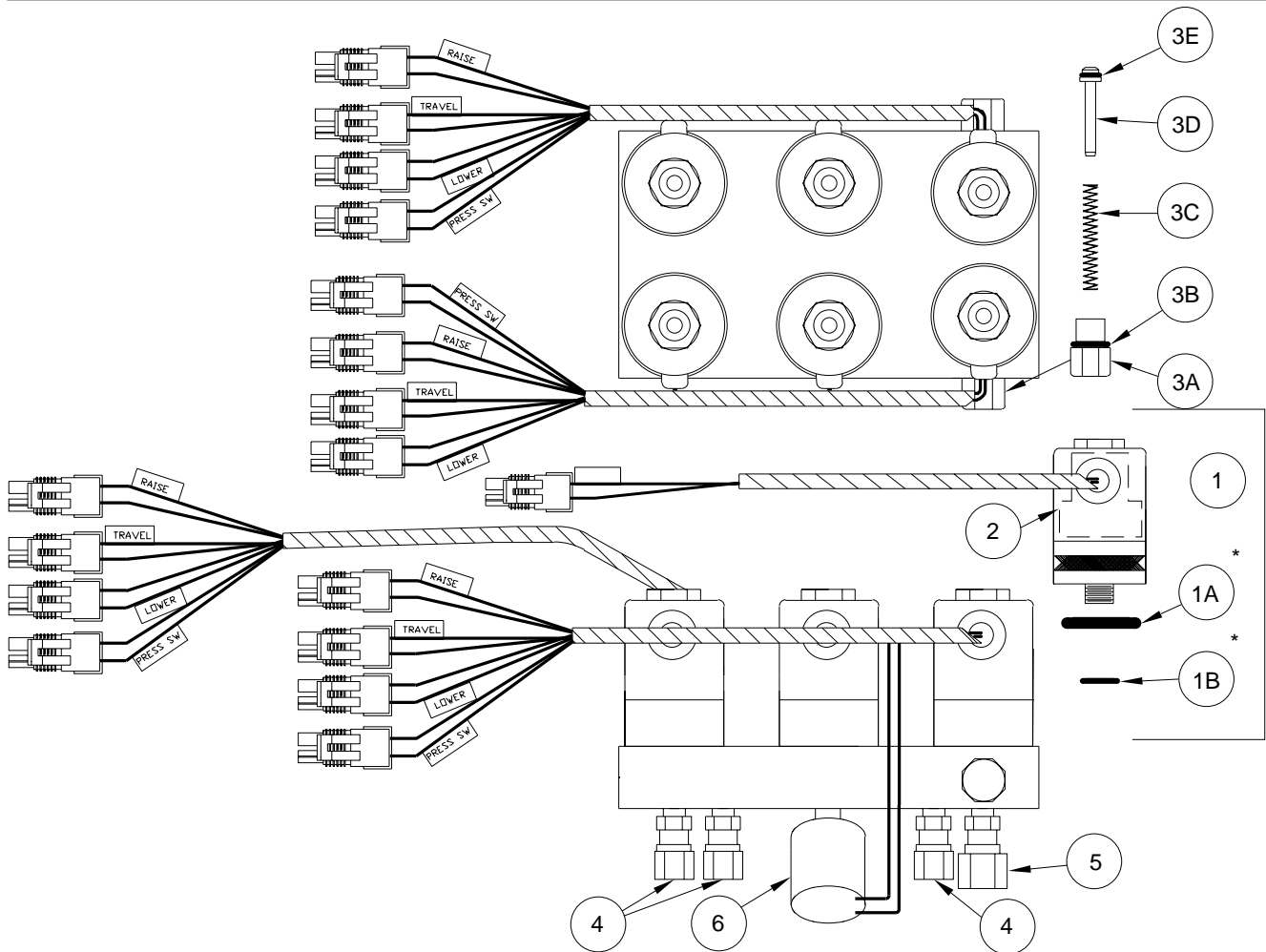

ITEM	PART	QTY	DESCRIPTION	ITEM	PART	QTY	DESCRIPTION
1	RAP1940	6	SOLENOID VALVE SCREW MOUNTED COMPLETE : INCLUDES 1A, 1B AND 2	4	RF6148	6	MALE CONNECTOR 1/8" X 3/8"
1A			O-RING	5	RF4478	1	MALE CONNECTOR 1/4" X 3/8"
1B			O-RING	6	RAP1720	2	SWITCH PRESSURE 20 PSI (INCLUDES WIRE LEADS)
	RAP6554	1	O-RING KIT COMPOSED OF (6) 1A AND (6) 1B				
2	RAP90568	1	REPLACEMENT COIL				
3	RAP6553	1	CHECK VALVE KIT				
3A		2	CAP				
3B		2	O-RING				
3C		2	SPRING				
3D		2	PLUNGER				
3E		2	O-RING				

* GREASE LIGHTLY PRIOR TO ASSEMBLY

NOTE : INDENTED ITEMS INCLUDED WITH PRECEDING ITEM.

MR05.3400
09MAY13