

MANIFOLD ASSEMBLY, AIR - 6 VALVE (AP26195) (WITH 3-PRESSURE SWITCHES)

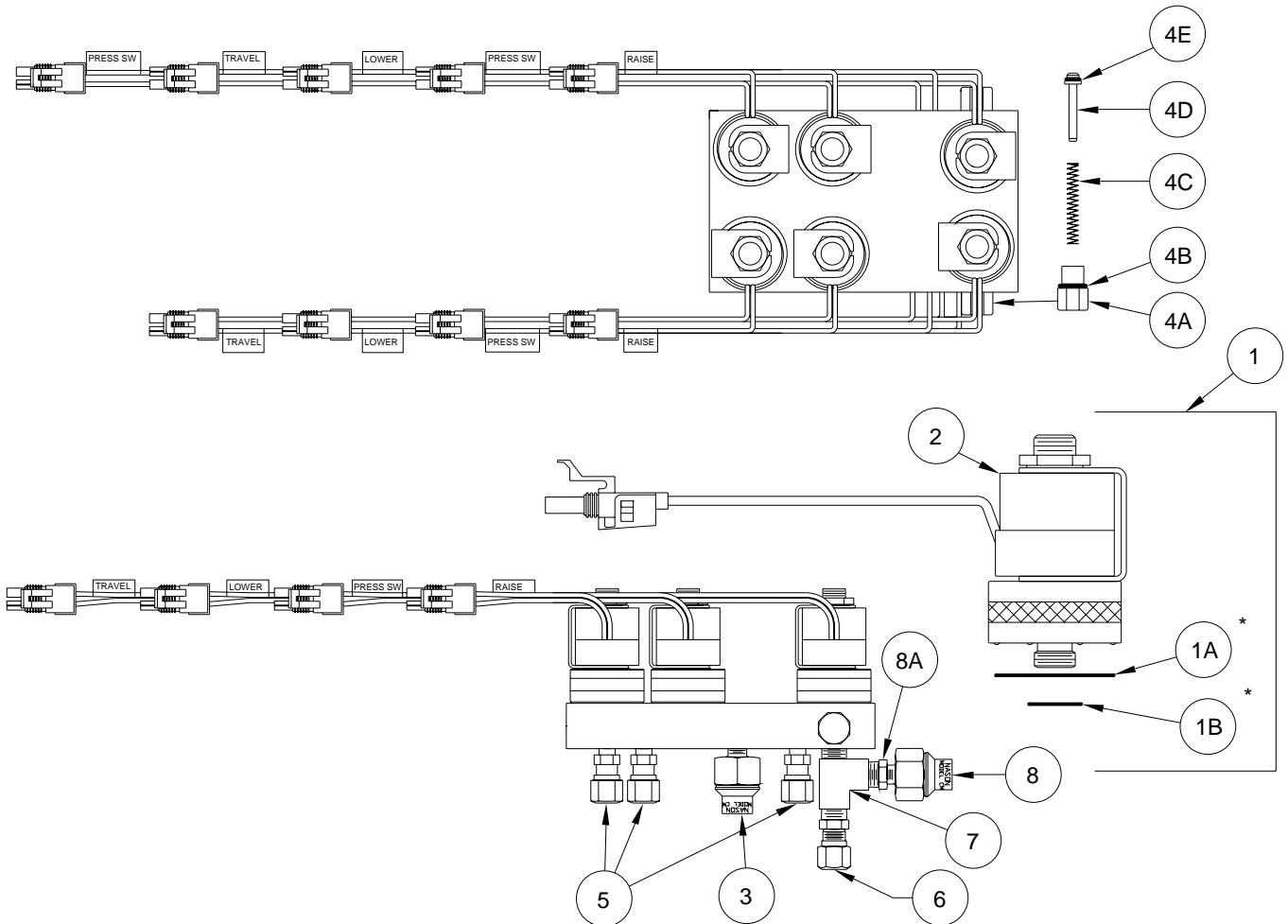

ITEM	PART	QTY	DESCRIPTION	ITEM	PART	QTY	DESCRIPTION
1	RAP1940	6	SOLENOID VALVE SCREW MOUNTED COMPLETE : INCLUDES 1A, 1B AND 2	4	RAP6553	1	CHECK VALVE KIT
1A			O-RING	4A		2	CAP
1B			O-RING	4B		2	O-RING
	RAP6554	1	O-RING KIT COMPOSED OF (6) 1A AND (6) 1B	4C		2	SPRING
2	RAP90568	1	REPLACEMENT COIL	4D		2	PLUNGER
3	RAP1720	2	SWITCH PRESSURE 20 PSI	4E		2	O-RING
				5	RF6148	6	MALE CONNECTOR 1/8" X 3/8"
				6	RF4478	1	MALE CONNECTOR 1/4" X 3/8"
				7	RF6944	1	1/4" STREET TEE
				8	RAP90570	1	SWITCH PRESSURE 85 PSI
				8A	RF90172	1	BRASS BUSHING 1/4" X 1/8"

* GREASE LIGHTLY PRIOR TO ASSEMBLY

NOTE : INDENTED ITEMS INCLUDED WITH PRECEDING ITEM.

MR05.3717
09MAY13